

2025



# Pentruder®

CONCRETE CUTTING SYSTEMS

Distributed by:



1990 - 2025

| WALL SAWS | WIRE SAWS | POWER CUTTERS | DIAMOND CHAINS |

**Pentruder**<sup>®</sup>  
CONCRETE CUTTING SYSTEMS

# UNBEATABLE PRECISION

Why settle for ordinary when you can own the best? Pentruder isn't just a saw; it's the Pentruder, the ultimate tool for professionals who don't compromise. Designed for those who demand precision, power, and performance, this cutting-edge masterpiece is engineered with one goal in mind: to leave everything else in the dust.

With a high-frequency motor that roars to life, aircraft-grade billet aluminum construction, and a multi-speed gearbox, the Pentruder is built for the toughest jobs. And let's talk about that 79" blade—the only one of its kind in the industry—that slices through concrete like a hot knife through butter.

When you show up with a Pentruder, you're not just showing up to work. You're stepping into the spotlight as the job site's rock star. The competition? They're left staring, slack-jawed and wide-eyed, wondering what kind of magic you're wielding.

You don't just cut concrete—you own it.



8-20 HF

p. 4

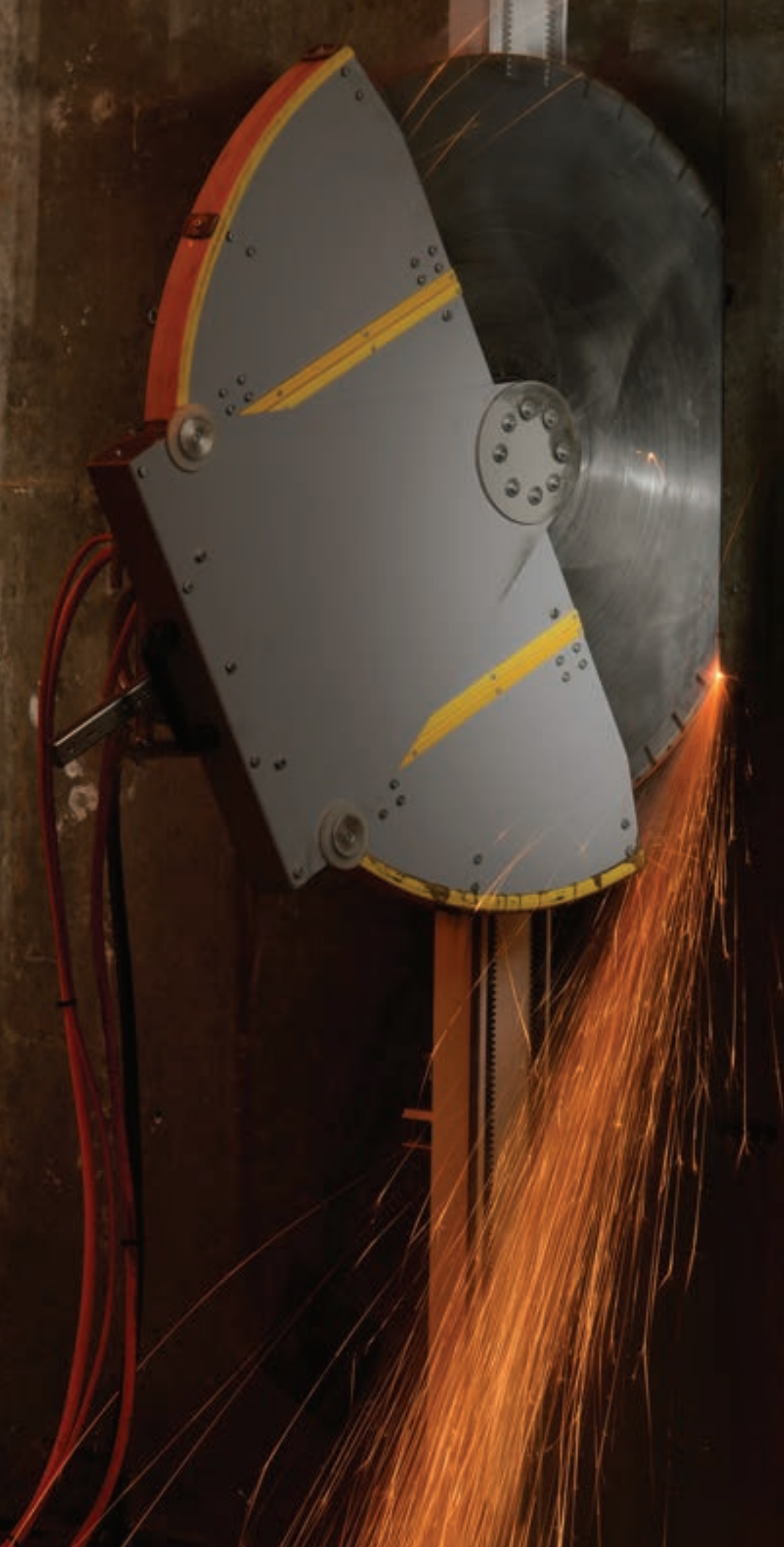

# 8-20 WALL SAW

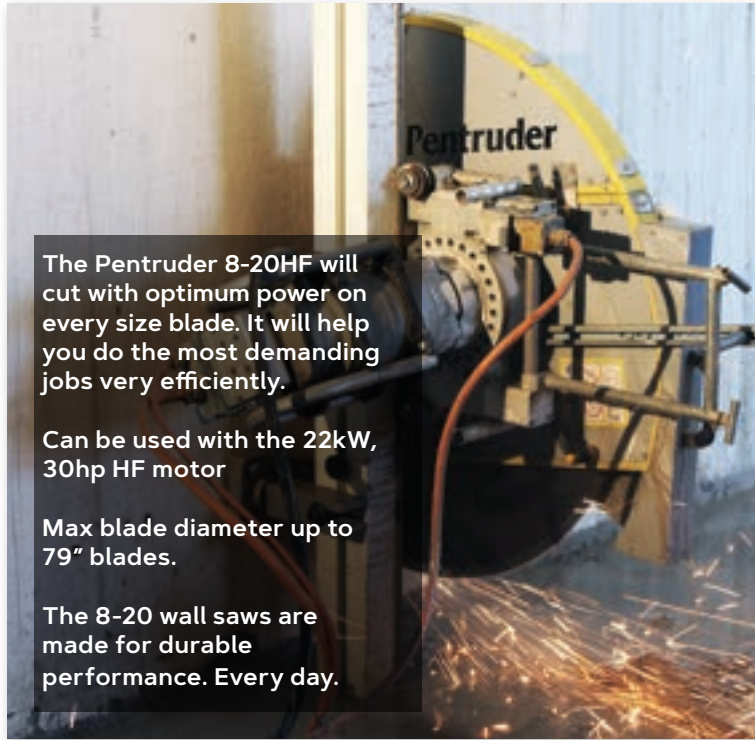

The Pentrunder 8-20HF will cut with optimum power on every size blade. It will help you do the most demanding jobs very efficiently.

Can be used with the 22kW, 30hp HF motor

Max blade diameter up to 79" blades.

The 8-20 wall saws are made for durable performance. Every day.

## PENTRUDER 8-20HF Specifications

### Saw blade motor

- 400 Hz high frequency motor

### Max continuous output power

- 22 kW 30hp

### Recommended fuse

- 50 Amp

### Max output torque

- 405 Nm in 1st gear

### Spindle Speed Under Load

| Gear | Speed       | RPM            | Blade Diameter (Max) |
|------|-------------|----------------|----------------------|
| 1st  | Low         | 350 - 510 rpm  | up to 79"            |
| 2nd  | Medium Low  | 500 - 735 rpm  | up to 63"            |
| 3rd  | Medium High | 630 - 925 rpm  | up to 48"            |
| 4th  | High        | 790 - 1165 rpm | up to 39"            |

### PENTRUDER 8-20 HF 22KW/30HP WALL SAW (MAX BLADE DIAMETER - 79", WILL TAKE 40" BLADE OUT OF CUT)

| PART NUMBER | DESCRIPTION                           | DETAILS                                |
|-------------|---------------------------------------|--|
| 09274001DIG | PENTPAK 427 DIGITAL COMMUNICATION     | INPUT 480V 60HZ - 3 PHASE              |
| 07224001DIG | HF-MOTOR 22 KW/30HP 400V DIG.COM.     | 400 VOLT 400HZ 30 HP                   |
| 10050101DIG | PENTRUDER 8-20 HF DIG.COM. (SAW HEAD) | UP TO 79" BLADE DIAM. 40" OUT OF CUT   |
| 42880601    | BLADE FLANGE, 1-3/8 W. HEX CPL        | BLADE FLANGE ASSEMBLY 1 3/8"           |
| 43210601    | FRAME BLADE GUARD HOLDER CPL          | MOUNTS TO SAW HEAD, HOLDS GUARD        |
| 11080701    | BLADE GUARD FULL 32"                  |  |
| 64190401    | REMOTE CONTROL HF CPL                 | WIRED REMOTE                           |
| 64900201    | CABLE 400V 30' DIGITAL COM. CPL       |  |
| 64900101    | CABLE 24V 30' DIGITAL COM. CPL        |  |
| 43101401    | TRACK FOOT SYMMETRIC CPL              | NEED 3 TRACK FEET TO SUPPORT 90" TRACK |
| 49031901    | TRACK 45" DOUBLE RACK CPL             |  |
| 49032201    | TRACK 90.5" DOUBLE RACK CPL           |  |
| 55070201    | TRACK STOP TP3 CPL                    | REQUIRES 2                             |
| 43280101    | JOINT BLOCK FOR TRACKS CPL            | CONNECTS 2 TRACKS                      |
| 64110800    | RECEPTACLE FEMALE 32A 400V            | FOR INPUT POWER 480V                   |
| 65340101    | TOOLKIT PENTRUDER WALLSAW CPL         | HAND TOOLS                             |
| 60480401    | WATER VALVE COMPLETE WITH COUPLING    | WATER CONNECTION TO PENTPAK            |
| 573700      | WATER HOSE KIT FOR PENTPAK 427        | WATER CONNECTION TO PENTPAK            |
| 64114800    | PROTECTIVE CAP, 100A DIG MALE         | PROTECTS ELECTRICAL CONNECTIONS        |
| 64114700    | PROTECTIVE CAP, 100A DIG FEMALE       | PROTECTS ELECTRICAL CONNECTIONS        |
| 64114600    | PROTECTIVE CAP, 24V DIG MALE          | PROTECTS ELECTRICAL CONNECTIONS        |
| 64114500    | PROTECTIVE CAP, 24V DIG FEMALE        | PROTECTS ELECTRICAL CONNECTIONS        |

# CBK WALL SAW

## PENTRUDER CBK Specifications

- Saw blade motor**
  - 400 Hz high frequency motor
- Max continuous output power**
  - 22 kW 30hp
- Recommended fuse**
  - 50 Amp
- Max output torque**
  - 275 Nm in 1st gear
- Saw blade diameter max.**
  - 63"
- Max cutting depth with max. blade**
  - 28.5"
- Max start blade**
  - 36"
- Total Weight: 93lbs**
  - 54lbs (Saw head)
  - 39lbs (22 kW motor)

The spindle speed is electronically variable with the remote control. See operator's manual for detailed charts.

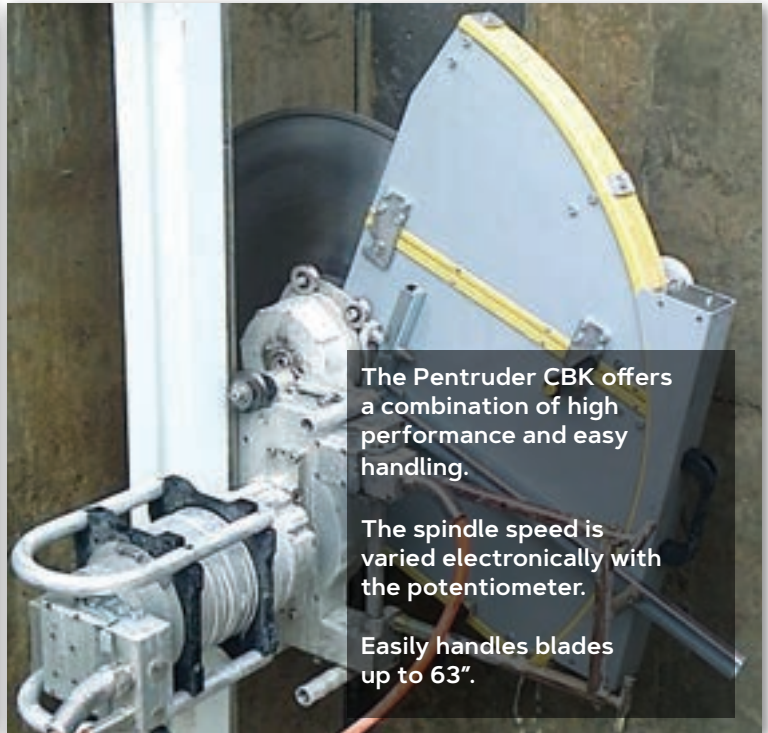

The Pentrunder CBK offers a combination of high performance and easy handling.

The spindle speed is varied electronically with the potentiometer.

Easily handles blades up to 63".

### PENTRUDER CBK HF 22KW/30 HP WALL SAW (MAX BLADE DIAMETER - 63", WILL TAKE 37" BLADE OUT OF CUT)

| PART NUMBER | DESCRIPTION                          | DETAILS                                |
|-------------|--------------------------------------|--|
| 09274001DIG | PENTPAK 427 DIGITAL COMMUNICATION    | INPUT 480V 60HZ - 3 PHASE              |
| 07224001DIG | HF-MOTOR 22 KW 400V DIG.COM.         | 400 VOLT 400HZ 30 H/P                  |
| 10090101DIG | PENTRUDER CBK-HF DIG.COM. (SAW HEAD) | UP TO 63"BLADE DIAM. 37"OUT OF CUT     |
| 42880601    | BLADE FLANGE, 1-3/8 W. HEX CPL       | BLADE FLANGE ASSEMBLY 1 3/8"           |
| 43210601    | FRAME BLADE GUARD HOLDER CPL         | MOUNTS TO SAW HEAD, HOLDS GUARD        |
| 11080701    | BLADE GUARD FULL 32"                 |  |
| 64190401    | REMOTE CONTROL HF CPL                | WIRED REMOTE                           |
| 64900201    | CABLE 400V 30' DIGITAL COM. CPL      |  |
| 64900101    | CABLE 24V 30' DIGITAL COM. CPL       |  |
| 43101401    | TRACK FOOT SYMMETRIC CPL             | NEED 3 TRACK FEET TO SUPPORT 90" TRACK |
| 49031901    | TRACK 45" DOUBLE RACK CPL            |  |
| 49032201    | TRACK 90.5" DOUBLE RACK CPL          |  |
| 55070201    | TRACK STOP TP3 CPL                   | REQUIRES 2                             |
| 43280101    | JOINT BLOCK FOR TRACKS CPL           | CONNECTS 2 TRACKS                      |
| 64110800    | RECEPTACLE FEMALE 32A 400V           | FOR INPUT POWER                        |
| 65340101    | TOOLKIT PENTRUDER WALLSAW CPL        | HAND TOOLS                             |
| 60480401    | WATER VALVE COMPLETE WITH COUPLING   | WATER CONNECTION TO PENTPAK            |
| 573700      | WATER HOSE KIT FOR PENTPAK 427       | WATER CONNECTION TO PENTPAK            |
| 64114800    | PROTECTIVE CAP, 100A DIG MALE        | PROTECTS ELECTRICAL CONNECTIONS        |
| 64114700    | PROTECTIVE CAP, 100A DIG FEMALE      | PROTECTS ELECTRICAL CONNECTIONS        |
| 64114600    | PROTECTIVE CAP, 24V DIG MALE         | PROTECTS ELECTRICAL CONNECTIONS        |
| 64114500    | PROTECTIVE CAP, 24V DIG FEMALE       | PROTECTS ELECTRICAL CONNECTIONS        |



# RS2 WALL SAW



The Pentrunder RS2 is a no-compromise, lightweight wall saw

Pentpak 3 drives a range of HFI products

Same track system as other Pentrunder saws

Modular system with significantly lower weight

## PENTRUDER RS2 Specifications

### Saw blade motor

- Integrated torque motor

### Max continuous output power

- 18 kW 24hp

### Max output torque

- 148 Nm

### Saw blade diameter max.

- 63"

### Max cutting depth with max. blade

- 28."

### Max start blade

- 32"

### Spindle speed under load

- 570 - 1050 rpm

### Total Weight Saw head & motor

- 54lbs

## THE RS2, POWERED BY THE ALL NEW PENTRUDER HFI DRIVE SYSTEM FEATURES:

- Shorter setup times
- Quick disconnect coupling for blade
- Easy fitting of blade
- Only one connector
- Simple to connect and disconnect
- Light weight, easy to fit blade guard
- Best protection and handling
- High power torque motor
- Revolutionary one-of-a-kind integrated torque motor
- Very high system efficiency means more power to the saw blade

## MODULARITY AND SIMPLICITY

- Pentpak 3 drives a range of HFi products
- Modular system with significantly lower machine weight
- Same track system as all other Pentrunder machines
- Highest stability and best handling
- Designed with the customer in mind
- Less components
- Very easy oil change
- Replace connector inserts easily with standard hand tools
- Efficient slip clutches for all motors
- Brushless feed motors

**PENTRUDER RS2 WALL SAW  
(MAX BLADE DIAMETER - 63", WILL TAKE 37" BLADE OUT OF CUT)**

| PART NUMBER | DESCRIPTION                          | DETAILS   |
|-------------|--------------------------------------|---|
| RS2-400     | WALL SAW RS2                         |   |
| PP3-480     | PENTPAK 3 480V                       |   |
| MCE-6-WE    | MACHINE CABLE HFi, 6 mm <sup>2</sup> |   |
| RRC-CE      | RADIO REMOTE CONTROL RRC             | CONSISTS OF RRC RADIO REMOTE CONTROL AND CE-RRC CABLE |
| QERS-60     | BLADE FLANGE RS Ø 60 CPL             | INNER AND OUTER FLANGE AND SCREWS                     |
| GH-RS2      | BLADE GUARD HOLDER RS2               |   |
| GPRS-8      | BLADE GUARD FULL RS Ø 800 mm / 32"   |   |
| 65340401    | TOOL KIT RS2                         |   |
| 43101401    | TRACK FOOT SYMMETRIC CPL             | PURCHASE 3  |
| 49031901    | TRACK 45" DOUBLE RACK CPL            | PURCHASE 1  |
| 49032201    | TRACK 90.5" DOUBLE RACK CPL          | PURCHASE 1  |
| 55070201    | TRACK STOP TP3 CPL                   | PURCHASE 2  |
| 43280101    | JOINT BLOCK FOR TRACKS CPL           | PURCHASE 1  |
| 573700      | WATER HOSE KIT FOR PENTPAK 427       |   |

**RS2 OPTIONAL ITEMS**

| PART NUMBER | DESCRIPTION                                     | DETAILS |
|-------------|---|---------|
| TY-RS2      | TRANSPORT TROLLEY FOR RS2                       |         |
| CE-RRC      | CABLE FOR REMOTE CONTROL                        |         |
| 89090100    | WAIST BELT FOR REMOTE CONTROL                   |         |
| 89090200    | SHOULDER STRAP FOR RMTE CONTROL                 |         |
| 89090300    | SHOULDER HOOK FOR REMOTE CONTROL                |         |
| GH-RS2      | BLADE GUARD HOLDER FOR GPRS & GFRS BLADE GUARDS |         |
| QERS-60     | BLADE FLANGE RS Ø60                             |         |
| QEFRS-108   | FLUSH CUTTING FLANGE BC = 108                   |         |
| GPRS-8      | BLADE GUARD, RS, Ø 800MM/32IN                   |         |
| GPRS-12     | BLADE GUARD, RS, Ø 1200MM/48IN                  |         |
| GPRS-16     | BLADE GUARD, RS, Ø 1600MM/63IN                  |         |
| GFRS-8      | BLADE GUARD FLUSH, RS, Ø 800MM/32IN             |         |
| GFRS-12     | BLADE GUARD, FLUSH RS, Ø 1200MM/48IN            |         |
| GFRS-16     | BLADE GUARD FLUSH, RS, Ø 1600MM/63IN            |         |



# OVERVIEW PENTRUDE CONCRETE CUTTING SYSTEM

## HF-POWER PACKS

Pentpak 427, 3-phase

Remote control and cables

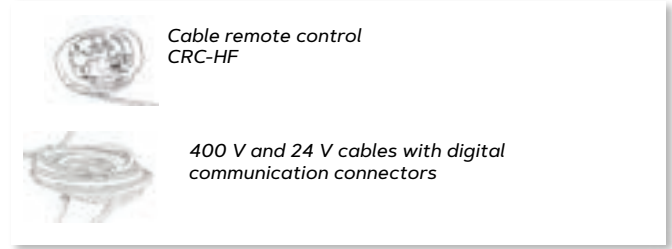

## ELECTRICAL MOTORS

22 kW 30hp



22 kW 30hp

Pentrunder 8-20HF

22 kW HF 30hp

Pentrunder CBK

## WALL SAWS

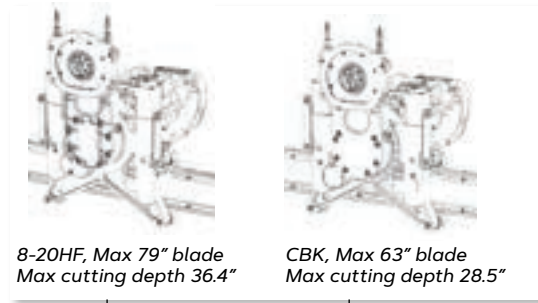

## TRACK SYSTEM FOR WALL SAWING

Single T-slot track (TS)

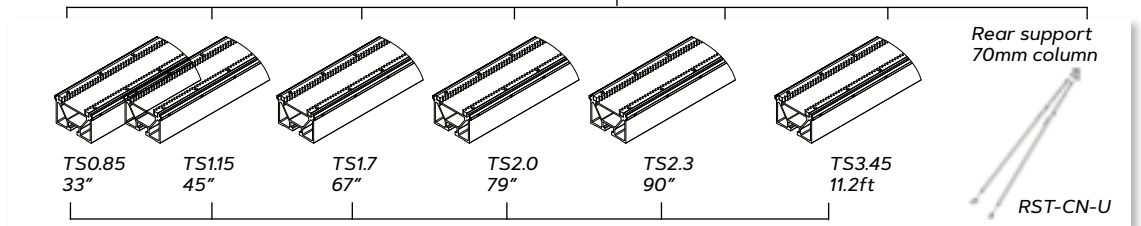

Track foot  
symmetric TF2S



Track foot  
angular TFAB

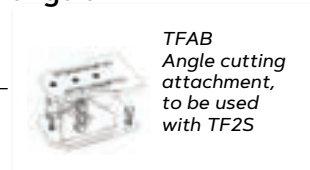

Base plate BTS-5





# OPTIONAL ACCESSORIES

| PENTRUDER OPTIONAL ITEMS |                                       |                                 |
|--------------------------|---------------------------------------|---------------------------------|
| PART NUMBER              | DESCRIPTION                           | DETAILS                         |
| 7810101P                 | TROLLEY FOR HF-SAWS, ASSEMBLED        | TRANSPORTS WALL SAW / 2 TRACKS  |
| 11080701                 | BLADE GUARD FULL 32"                  |                                 |
| 11081601                 | BLADE GUARD FULL 42"                  |                                 |
| 11080901                 | BLADE GUARD FULL 48"                  |                                 |
| 11081701                 | BLADE GUARD FULL 54"                  |                                 |
| 11081001                 | BLADE GUARD FULL 63"                  |                                 |
| 11081101                 | BLADE GUARD FULL 79"                  | AVAILABLE ONLY FOR THE 8-20HF   |
| 11090601                 | FLUSH BLADE GUARD 32"                 |                                 |
| 11091001                 | FLUSH BLADE GUARD 42"                 |                                 |
| 11090801                 | FLUSH BLADE GUARD 48"                 |                                 |
| 11091101                 | FLUSH BLADE GUARD 54"                 |                                 |
| 11090901                 | FLUSH BLADE GUARD 63"                 |                                 |
| 49031801                 | TRACK 33" DOUBLE RACK CPL             |                                 |
| 49031901                 | TRACK 45" DOUBLE RACK CPL             |                                 |
| 49032001                 | TRACK 67" DOUBLE RACK CPL             |                                 |
| 49032101                 | TRACK 79" DOUBLE RACK CPL             |                                 |
| 49032201                 | TRACK 90.5" DOUBLE RACK CPL           |                                 |
| 49032301                 | TRACK 11" DOUBLE RACK CPL             |                                 |
| 43280101                 | JOINT BLOCK FOR TRACKS CPL.           | CONNECTS 2 TRACKS               |
| 43101401                 | TRACK FOOT SYMMETRIC CPL              | FOOT SWIVELS FOR FASTER SET UP  |
| 43100901                 | ANGLE-ADJUSTABLE TRACK FOOT           |                                 |
| 42880501                 | BLADE FLANGE SUB ASSY, 1IN W. HEX CPL | 1" ARBOR                        |
| 42040801                 | FLUSH CUT. FLANGE 1" BC-4-1/4" CPL    | 1" ARBOR/PENTRUDER              |
| 42880601                 | BLADE FLANGE SUB-ASSY 1-3/8"BORE CPL  | BLADE FLANGE ASSEMBLY 1 3/8"    |
| 42040401                 | FLUSH CUTTING FLANGE 1-3/8" USA CPL   | 1 3/8" ARBOR/PENTRUDER          |
| 43850101                 | LRG. DRILL TEMPLATE, SYM. TRACK FOOT  |                                 |
| 64114800                 | PROTECTIVE CAP, 100A DIG MALE         | PROTECTS ELECTRICAL CONNECTIONS |
| 64114700                 | PROTECTIVE CAP, 100A DIG FEMALE       | PROTECTS ELECTRICAL CONNECTIONS |
| 64114600                 | PROTECTIVE CAP, 24V DIG MALE          | PROTECTS ELECTRICAL CONNECTIONS |
| 64114500                 | PROTECTIVE CAP, 24V DIG FEMALE        | PROTECTS ELECTRICAL CONNECTIONS |
| 60480401                 | VALVE FOR WATER HOSE WITH QD          |                                 |
| 573700                   | WATER HOSE KIT FOR PENTPAK 427        |                                 |
| 85041600L                | WORM GEAR OIL, OMEGA 680 - LITRE      |                                 |
| 85041700L                | GEAR OIL, OMEGA 690 - LITRE           |                                 |
| 85040500L                | GEAR OIL, 626 - LITRE                 |                                 |

# WIRE SAW



Combines low weight with extraordinary performance

Suitable for both small and very big jobs.

Quick and easy set up.

All wire saw modules weigh less than 55 lbs.

Electrical automatic feed makes starting the wire easy.

The automatic feed extends the lifetime of the wire.

Optimal force transmission, and superb traction when the wire has low tension during start up.

## PENTRUDER 3p8 Wire Saw Add On Package Specifications

Drive motor

- 400Hz HF motor

Max continuous output power

- 18 kW 24hp

Main drive pulley

- 20"

Storage pulley

- 8" O.D.

Wire

- 8-12mm

Storage in pulleys

- 21 feet

Storage capacity

- 3 ft per 1 ft stroke of the carriage
- Max approximately 65ft

3P8-DP-HF Drive pulley, electric

- 30 lbs

3P8-UA Upper Assembly

- 33 lbs

3P8-UA Lower Assembly

- 43 lbs + 28 lbs

### 3P8 WIRE SAW ADDITION (STORAGE CAPACITY UP TO 65')

| PART NUMBER   | DESCRIPTION                             | DETAILS              |
|---------------|---|----------------------|
| BFC5          | BASE PLATE                              |                      |
| WT-BFC5-300   | BASE PLATE WHEEL KIT                    |                      |
| RST-CN-U      | REAR SUPPORT, COLUMN W/O MALE CONE      |                      |
| 10211201      | COLUMN 47.2" STEEL COMPLETE             | REQUIRES 2           |
| CE1-70-MD1    | CARRIAGE, CE1 W/FRICTION BRAKE, FOR 3P8 |                      |
| CE1-70-3P8-PT | CARRIAGE, CE1 FOR 3P8, W/ELECTRIC FEED  |                      |
| 10900101      | DRIVE PULLEY 3P8 HF CPL                 |                      |
| 57253101      | CLUTCH ASSEMBLY 3P8                     |                      |
| 10910201      | LOWER ROLLER STORAGE 3P8 CPL            |                      |
| 10910101      | UPPER ASSEMBLY 3P8 CPL                  |                      |
| 11200201      | GUARD, MAIN DRIVE PULLEY 3P8 CPL        |                      |
| 11200301      | GUARD, STORAGE PULLEYS 3P8 CPL          |                      |
| 11200401      | GUARD, TOP PULLEYS 3P8 CPL              |                      |
| 11200501      | GUARD, SLACK SIDE CHANNEL 3P8 CPL       |                      |
| 65340301      | TOOLKIT PENTRUDER 3P8 CPL               |                      |
| 64114500      | PROTECTIVE CAP 24V DIG FEMALE           |                      |
| 7710201       | SATELLITE PULLEY, ANGLED CPL            | 180 DEGREES ROTATION |

### Rig 70 mm Column System



CN-F/M  
Column, Female/Male  
coupling 47" x 2



BFC5  
Base plate with fixed swivelling coupling



CE1-70-3P8  
Upper carriage,  
automatic feed

CE1-70  
Carriage, with FE1  
Friction brake



### Wire Saw Modules



3P8-UA  
Upper assembly



3P8-LA  
Lower assembly



3P8-DP-HF  
Drive pulley, electric



Slip clutch  
for HF motor

### Wire Saw Guard



3P8-TG  
Guard, upper  
assembly



3P8-DPG  
Guard,  
drive pulley



3P8-LMG  
Guard, storage pulleys



3P8-SSG  
Guard, slack side  
telescoping guard

### Accessories



WSP2-90  
Satellite pulleys,  
universal, 2-link, 90°



WSP2-180  
Satellite pulleys,  
universal, 2-link, 180°



Covers for digital connectors



Toolkit



# DIAMOND WIRE

| DIAMOND WIRE ACCESSORIES |                                  |                                      |
|--------------------------|----------------------------------|--------------------------------------|
| P/N                      | Description                      | Compatibility                        |
| 571262                   | Straight                         | (Fits 4.8MM cable diameter, 30 pcs.) |
| 576286                   | Screw                            | (Fits 4.8MM cable diameter, 30 pcs.) |
| 571265                   | Swivel Connector (1 Pin)         | (Fits 4.8MM cable diameter)          |
| 571263                   | Double Swivel Connector (2 Pins) | (Fits 4.8MM cable diameter)          |
| 571268                   | Swivel Pin Remover               | (For p/n 571265 & 571263)            |
| 571267                   | Press                            | (5 Tons)                             |
| 571266                   | Wire Crimping Die                | (Fits 4.8MM cable diameter)          |
| 602450                   | Wire Cutting Die                 | (Fits 4.8MM cable diameter)          |



| DIAMOND WIRE         |          |                                      |           |     |            |
|----------------------|----------|--------------------------------------|-----------|-----|------------|
| Spec                 | Part No. | Description                          | Bead Dia. | BPM | Cable Dia. |
| <b>BRAZED</b>        |          |                                      |           |     |            |
| B1UV                 | 584024   | BRAZED WIRE, B1UV BLUE, 100FT        | 10.5MM    | 40  | 4.8MM      |
| B1UV                 | 647458   | BRAZED WIRE, B1UV BLUE, 120 FT       | 10.5MM    | 40  | 4.8MM      |
| B1UV                 | 584026   | BRAZED WIRE, B1UV BLUE, 328FT (100M) | 10.5MM    | 40  | 4.8MM      |
| B10                  | 575155   | BRAZED WIRE, B10, STEEL, 100FT       | 10.2MM    | 44  | 4.8MM      |
| <b>SINTERED</b>      |          |                                      |           |     |            |
| S14                  | 573146   | SUPER WIRE, SINTERED, S14, 100FT     | 11 MM     | 40  | 4.8MM      |
| <b>ELECTROPLATED</b> |          |                                      |           |     |            |
| E5                   | 573160   | PLATED WIRE, E5, RESCUE, 100FT       | 8.8MM     | 40  | 4.8MM      |
| E6                   | 645278   | PLATED WIRE, E6, 328FT (100M)        | 15.0MM    | 40  | 4.8MM      |
| E17                  | 602842   | PLATED WIRE, E17, 100FT              | 10.5MM    | 53  | 4.8MM      |
| E17                  | 601976   | PLATED WIRE, E17, 328FT (100M)       | 10.5MM    | 53  | 4.8MM      |
| E16                  | 612156   | PLATED WIRE, E16, 100FT              | 13.0MM    | 40  | 4.8MM      |
| E16                  | 607879   | PLATED WIRE, E16, 328FT (100M)       | 13.0MM    | 40  | 4.8MM      |

**BRAZED WIRE**

From pure steel to reinforced concrete, brazed wire is optimized for long life and fast cutting speed.

**SINTERED WIRE**

Designed for smooth operation and extremely efficient use of the diamonds. Our longest life wire

**ELECTROPLATED WIRE**

The proprietary design efficiently uses diamonds and offers a fast and stable speed through the cut

# CUSTOMER SATISFACTION POLICY

## QUALITY AND SERVICE YOU CAN COUNT ON

At ICS, our goal is help you get the job done right with outstanding products that perform to your full satisfaction. If for any reason, you are not satisfied with our products, please let us know. Our contact information is listed below.

The **ICS limited warranty** is offered for 90 days (30 days if product is used in rental) from date of original purchase on ICS® Brand manufactured parts. Components not manufactured by ICS will be covered for the period and according to the provisions of each manufacturer's warranty. During the warranty period, ICS will replace or, at its option, repair for the original purchaser only, free of charge, any product or part manufactured by ICS which is found upon examination by ICS to be defective in material and/or workmanship. The purchaser shall be responsible for all transportation charges and any cost of removing any part submitted for replacement under this warranty. This warranty does not cover any failure caused by accident, abuse, misuse, improper maintenance, normal wear, neglect, damage caused by stale or improper fuel mix or operation under conditions not specified by ICS. There are no other warranties expressed or implied. There is no implied warranty of merchantability and no implied warranty of fitness for a particular purpose. Replacement or repair is the exclusive remedy, and ICS disclaims all liability for incidental and consequential damages of any kind.

This **Pentrunder Limited warranty** is limited to defects and malfunctions which appear during a period expiring after 12 months from the date of original purchase. The date of purchase must be verified with a copy of an invoice. Any servicing performed during the warranty period will not result in an extension or renewal of the warranty.

During the warranty period, Pentrunder will repair or replace any parts or equipment that are determined, at the sole discretion of Pentrunder, to be defective in materials or workmanship.

Warranty coverage is expressly denied for any parts or equipment that:

- Are rendered defective as a result of misuse, negligence or carelessness either in the use or storage (e.g. failure to follow the instructions in the operating manuals);
- Are rendered defective as a result of improper maintenance or repairs performed by unauthorized persons;
- Have been damaged during transport;
- Are with defects not ascribable to faulty workmanship, but rather to the required replacement due to wear and tear that occurs during normal use;
- Perform inefficiently as a result of the use of spare parts other than those manufactured or supplied by Pentrunder;
- Have been damaged by lightning discharges, submerging in water or other fluids, fire, incompatible voltages or any other cause not objectively ascribable to Pentrunder;
- Have been altered by the customer or used with accessories in a way which is not approved by Pentrunder.

There are no other warranties expressed or implied. There is no implied warranty of merchantability and no implied warranty of fitness for a particular purpose. Replacement or repair is the exclusive remedy, and Pentrunder disclaims all liability for incidental and consequential damages of any kind.

### ICS PRO USER SALES TEAM

**JUSTIN DEAN | N. CALIFORNIA, N. NEVADA**  
916.212.0015 | justin.dean@oregontool.com

**ROD DEJONG | CA, NV, AZ, HI, NM**  
503.260.2569 | rod.dejong@oregontool.com

**ERIC FREEDLUND | IN, IA, IL, KY, MI, MN, NE, ND, OH, SD, WI**  
503.314.8977 | eric.freedlund@oregontool.com

**DOUG GALLAGHER | OR, WA, ID, MT, WY**  
971.754.5158 | doug.gallagher@oregontool.com

**MATTHEW HOLT | AL, GA, MS, NC, TN, SC**  
971.317.6322 | matthew.holt@oregontool.com

**MIKE HOSIER | CT, DE, ME, MA, NH, NJ, NY, PA, RI, VT, DC, WV**  
**CANADA: ON, QC, NB, NL**  
503.708.2701 | mike.hosier@oregontool.com

**JUSTIN KING | AR, CO, KS, MO, OK**  
503.860.0442 | justin.king@oregontool.com

**BRAD MUSHINSKY | FLORIDA**  
541.205.1418 | brad.mushinsky@oregontool.com

**ANDY WEYRENS | TX, LA**  
503.341.1818 | andy.weyrens@oregontool.com

## CONTACT US

### Hours:

Monday - Friday  
6:00 a.m. to 4:00 p.m. (Pacific Time)

**Phone:** 800.321.1240

**Email:** ics.orders@oregontool.com

**Website:** icsdiamondtools.com

### Mailing Address:

ICS Customer Service  
Oregon Tool, Inc.  
P.O. Box 22127  
Portland, OR 97269-2127

Copyright 2025 ICS, Oregon Tool Inc. Pricing, product offerings and specifications are subject to change without notice. FORCE3, FORCE4, PowerGrit, SpeedHook, SealPRO, and WallWalker are registered trademarks of ICS. The best way to cut concrete, DCT, Speed King, TSS, Trident and ProFORCE are trademarks of ICS.

# HIGH-FREQUENCY CHAIN SAW



Designed to run ICS bars, FORCE4® and PowerGrit® chains and ICS drive sprockets for optimum performance with cutting depths up to 25”.

High quality, reliable drive motor with 9 kW 12hp output power on the power cutter.

Easy to use indoors without emissions or hydraulic hoses.

Runs from the Pentpak HF power packs.

Engineered to stand up to your toughest jobs, thanks to efficient motor

## PENTRUDER CWF630HF Flush Cut Specifications

**Weight (with 15” bar & chain)**  
- 33 lbs

**Bar/Chain lengths**  
- 10”, 15”, 20” & 25”

**Motor Speed**  
- 6500 rpm

**Powerhead dimensions**  
- Length 23”  
- Height 10.4”  
- Width 9.4”

**Output power**  
- 9 kW

**Vibration level**  
- 2.4 m<sup>2</sup>/sec (front handle)  
- 4.5 m<sup>2</sup>/sec (rear handle)

**Sound level**  
- 94 dB @ 1m

**Noise level**  
- 1 - 3 dB @ 1m

**Water Flow**  
2gpm/8lpm (minimum)

**Water Supply Requirements**  
Minimum 20psi (1.4bar)





# ICS® DIAMOND CHAIN

| LENGTH   | CHAIN TYPE                            | CHAIN                | GUIDEBAR | SPROCKET      | POWERHEAD |
|--|---------------------------------------|----------------------|----------|---------------|-----------|
| <b>10 inch / 25 cm (25 Segments)</b>                   |                                       |                      |          |               |           |
| 10"/25 cm  | FORCE4® with Trident Seg. Tech        | 648023               | 635704   | 565065        | see below |
| 10"/25 cm  | FORCE4® Prem L with Trident Seg. Tech | 644740               | 635704   | 565065        | see below |
| 10"/25 cm  | FORCE4® Premium S, Speed King         | 649994               | 635704   | 565065        | see below |
| 10"/25 cm  | FORCE4® Abrasive Chain                | 531747               | 635704   | 565065        | see below |
| 10"/25 cm  | FORCE4® Cross-LINK®                   | 599881               | 635704   | 565065        | see below |
| 10"/25 cm  | FORCE4® Sandwich Segment              | 605443               | 635704   | 565065        | see below |
| 10"/25 cm  | FORCE4® Texas Edition                 | 598280               | 635704   | 565065        | see below |
| 10"/25 cm  | PowerGrit® Chain                      | 547641               | 635704   | 565065        | see below |
| 10"/25 cm  | PowerGrit® XL Chain                   | 608233               | 635704   | 565065        | see below |
| <b>15 inch / 38 cm (29 Segments)</b>                   |                                       |                      |          |               |           |
| 15"/38 cm  | FORCE4® with Trident Seg. Tech        | 648025               | 635700   | 565065        | see below |
| 15"/38 cm  | FORCE4® Prem L with Trident Seg. Tech | 644741               | 635700   | 565065        | see below |
| 15"/38 cm  | FORCE4® Premium S, Speed King         | 649995               | 635700   | 565065        | see below |
| 15"/38 cm  | FORCE4® Abrasive Chain                | 525344               | 635700   | 565065        | see below |
| 15"/38 cm  | FORCE4® Cross-LINK®                   | 599882               | 635700   | 565065        | see below |
| 15"/38 cm  | FORCE4® Sandwich Segment              | 605414               | 635700   | 565065        | see below |
| 15"/38 cm  | FORCE4® Texas Edition                 | 598281               | 635700   | 565065        | see below |
| 15"/38 cm  | PowerGrit® Chain                      | 537764               | 635700   | 565065        | see below |
| 15"/38 cm  | PowerGrit® XL Chain                   | 607664               | 635700   | 565065        | see below |
| <b>20 inch / 50cm (32 Segments)</b>                    |                                       |                      |          |               |           |
| 20"/50 cm  | FORCE4® with Trident Seg. Tech        | 648026               | 635703   | 565065        | see below |
| 20"/50 cm  | FORCE4® Prem L with Trident Seg. Tech | 644742               | 635703   | 565065        | see below |
| 20"/50 cm  | FORCE4® Premium S, Speed King         | 649996               | 635703   | 565065        | see below |
| 20"/50 cm  | FORCE4® Abrasive Chain                | 531753               | 635703   | 565065        | see below |
| 20"/50 cm  | FORCE4® Cross-LINK®                   | 599883               | 635703   | 565065        | see below |
| 20"/50 cm  | FORCE4® Sandwich Segment              | 605400               | 635703   | 565065        | see below |
| 20"/50 cm  | FORCE4® Texas Edition                 | 598282               | 635703   | 565065        | see below |
| 20"/50 cm  | PowerGrit® Chain                      | 537765               | 635703   | 565065        | see below |
| 20"/50 cm  | PowerGrit® XL Chain                   | 608216               | 635703   | 565065        | see below |
| <b>25 inch / 63cm (40Segments)</b>                     |                                       |                      |          |               |           |
| 25"/63 cm  | FORCE4® with Trident Seg. Tech        | 648050               | 635702   | 565065        | see below |
| 25"/63 cm  | FORCE4® Prem L with Trident Seg. Tech | 644744               | 635702   | 565065        | see below |
| 25"/63 cm  | FORCE4® Premium S, Speed King         | 649997               | 635702   | 565065        | see below |
| 25"/63 cm  | FORCE4® Abrasive Chain                | 525347               | 635702   | 565065        | see below |
| 25"/63 cm  | FORCE4® Cross-LINK®                   | 599884               | 635702   | 565065        | see below |
| 25"/63 cm  | FORCE4® Sandwich Segment              | 605399               | 635702   | 565065        | see below |
| 25"/63 cm  | FORCE4® Texas Edition                 | 598283               | 635702   | 565065        | see below |
| 25"/63 cm  | PowerGrit® Chain                      | 545017               | 635702   | 565065        | see below |
| 25"/63 cm  | PowerGrit® XL Chain                   | 608215               | 635702   | 565065        | see below |
| <b>POWERHEAD</b>                                       |                                       |                      |          |               |           |
| Flush Cut Chain Saw, HF Electric (Powerhead only) 200V |                                       | Requires DIG Pentpak |          | CWF-630HF-200 |           |
| Flush Cut Chain Saw, HF Electric (Powerhead only) 400V |                                       | Requires DIG Pentpak |          | CWF-630HF-400 |           |

**ICS DIAMOND TOOLS & EQUIPMENT  
4909 SE INTERNATIONAL WAY  
PORTLAND, OR 97222**

**800.321.1240  
[icsdiamondtools.com](http://icsdiamondtools.com)**